

How to Select a Safe and Reliable Residential Inverter

During the global push to adopt clean energy and sustainable practices, more homeowners than ever are interested in photovoltaic (PV) system. Installing a PV system has become a common consideration for families seeking to save energy and explore investment opportunities.

It is easy to set up a residential PV system, however, how to select the components for a PV system, especially how to select an inverter largely determines the safety and reliability of the system power generation. This paper will guide homeowners and start-up installers how to select a safe and reliable residential inverter when planning to “Go Solar”.

Requirements from Users

Users of a typical residential PV system include end users, installers and Operations and Maintenance (“O&M”) teams. Their key requirements for a PV system, especially inverters, mainly focus on the following 3 issues.

- End users: Safe and reliable; supports robust applications;
- Installers: Complete solution; simple installation and commissioning;
- O&M teams: Sound maintenance system; Smart O&M tools for efficient servicing and response times.

Therefore, an ideal inverter, which can meet the above needs, can be regarded as a safe and reliable residential PV inverter.

Inverter Selection Tip 1 - Complete Portfolio & Support Rich Applications

Sungrow owns a complete series of residential inverters, suitable for mainstream residential rooftops in various countries.

	 SG2~3K-S	 SG3~8K3-D	 SG5~20KTL	
	 SH3K6~5K-30 (for LV Battery)	 SH3.6~6.0RS (for HV Battery)	 SH5.0~10RT (for HV Battery)	 SBP6K5 (LV Battery)
	 WiFi	 E-Net	 iSolarCloud WEB&APP	

In addition, Sungrow provides various residential products, supporting various applications, including PV Self-consumption, PV feeding into grid, Hybrid retrofit, AC coupling and TOU (Time of Use) utilizing.

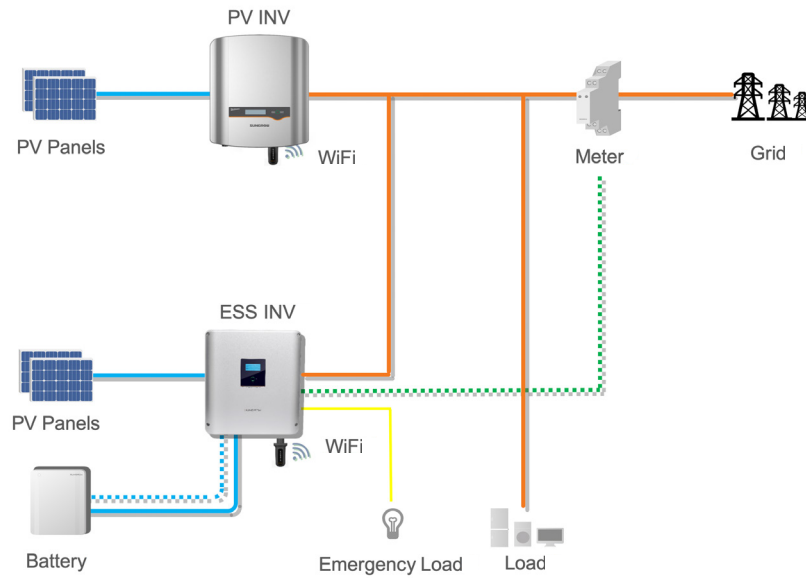

Inverter Selection Tip 2 – Outstanding Appearance & Fantastic Usage

Sungrow residential inverters combine a sleek and modern look and feel with outstanding technical features such as IP65 level waterproof & dustproof and C5 level anti-corrosion, which directly contribute to prolonging the “life” of inverters.

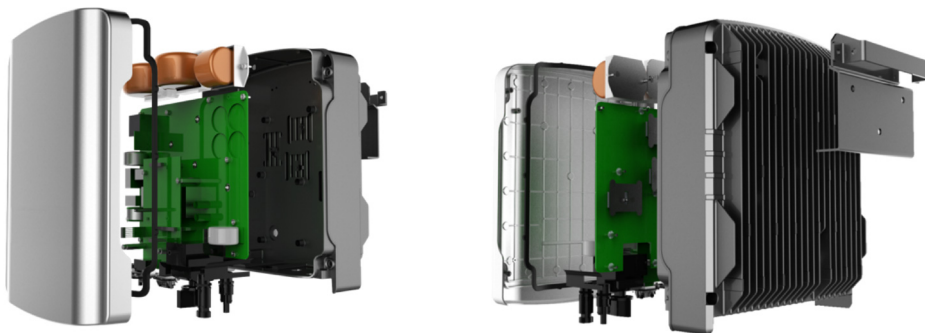

Additionally, Sungrow residential inverters characterize light weight and plug & play wiring design, making them easier for installation. The design of a leveling instrument on the mounting bracket of the inverter ensures a maximum heat-dissipation and mechanical safety when the inverter is installed horizontally.

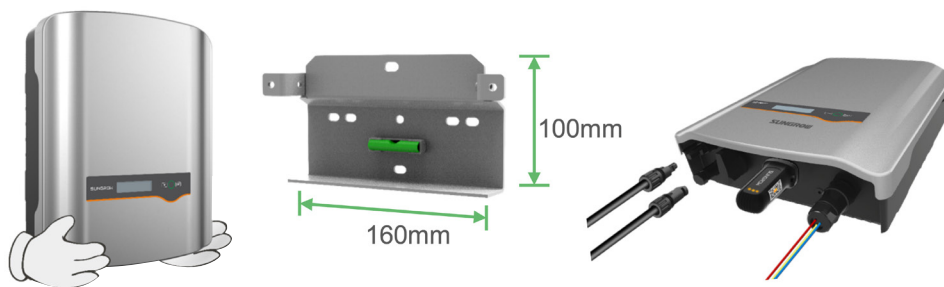

Inverter Selection Tip 3 – 24/7 Online Maintenance System

A safe and reliable inverter, not limited to product quality, but also on how to optimize ease of maintenance. Sungrow provides a completely remote monitoring system iSolarCloud, which enables both end users and O&M teams to check the health of the inverters and even the PV system at anytime and anywhere via computer or mobile devices. In the case of a fault, iSolarCloud can automatically send the alarm and intelligent solution to its users, which makes the O&M operation seamless.

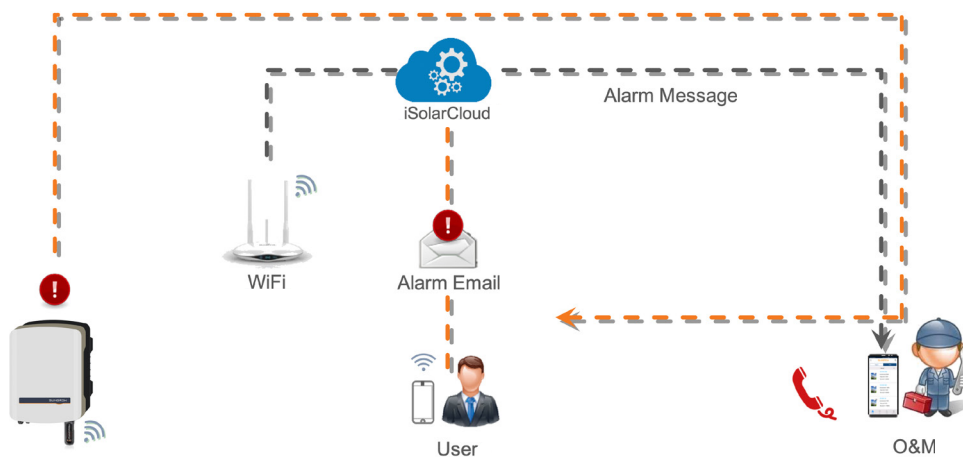

Inverter Selection Tip 4 – Safe & Reliable in Lightning & RCD Protection

Studies found that lightning & residual current protection is what concerns end users the most. Sungrow has launched a full protection design for its residential inverters and carefully selected lightning protection devices, including higher lightning-current-discharge-capacity varistors and gas discharge tubes with faster discharge speed and higher insulation between phase lines and the earth, which fully avoid the potential disasters caused by lightning.

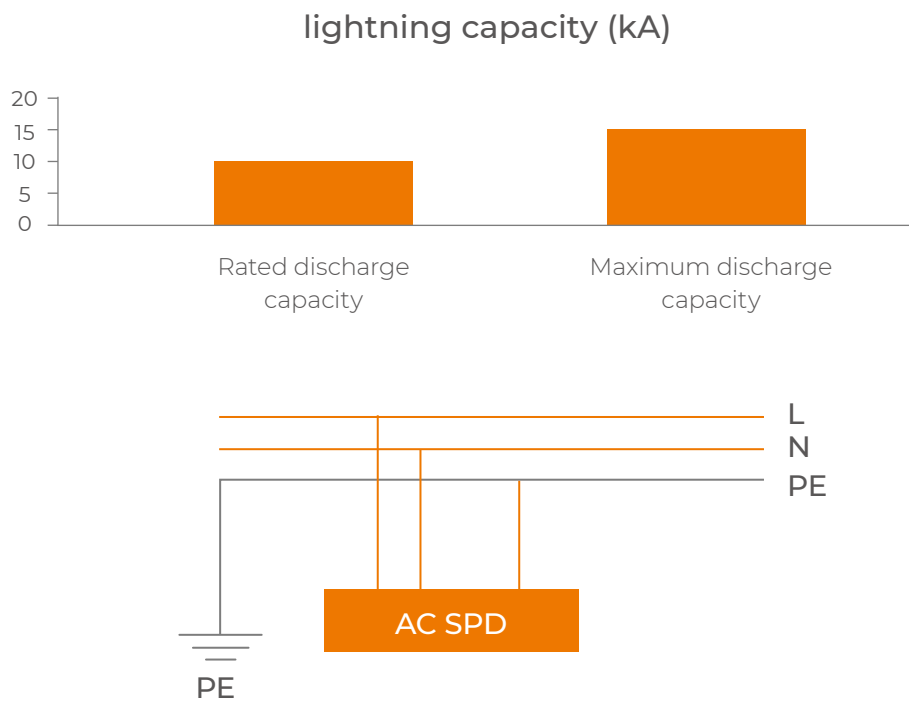

Sungrow residential inverters have higher residual current protection level than the standard requirements, more accurate detection and faster protection so as to eliminate the possibility of electric shock accidents to end users at any time.

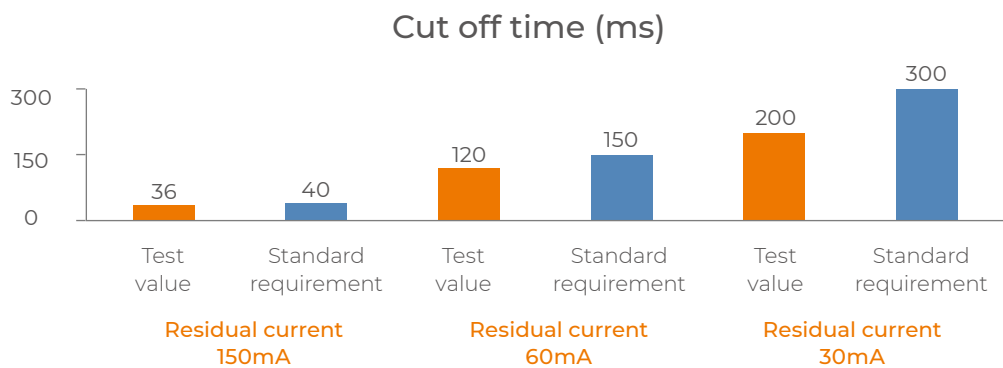

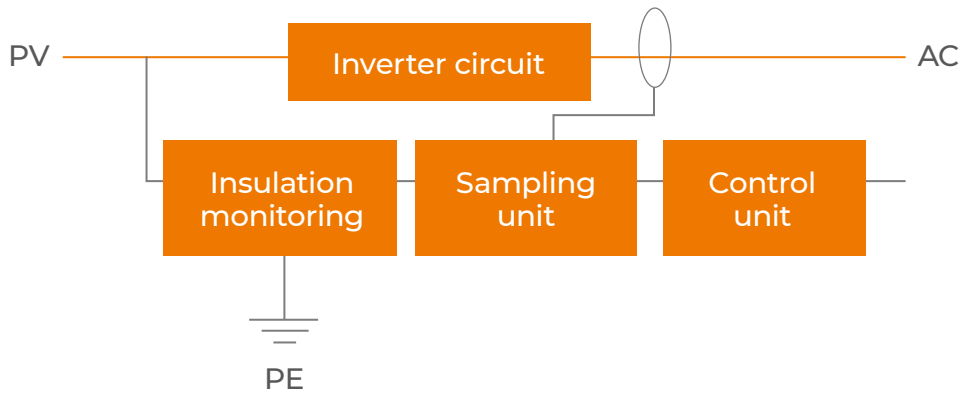

In summary, the key factors which should be paid attention to when selecting a safe and reliable residential inverter are security, reliability and user-friendly settings. Sungrow stands out among many brands with its ever-evolving technology and comprehensive sales, service and technical deployment. As of June 2019, Sungrow global shipments of residential inverters have approached 1.2GW, covering more than 10 countries across 5 continents with over 230,000 pcs of inverters supplied to tens of thousand of families.



**230,000 PCS +
Inverters**

**10+
Countries**

**1.2
GW**

This paper seeks to help these who are committed to clean energy lifestyle and are accelerating their step to enjoy safe and reliable Sungrow residential inverters.